

ETSI EN 300 833 V1.4.1 (2002-11)

European Standard (Telecommunications series)

**Fixed Radio Systems;
Point-to-point antennas;
Antennas for point-to-point fixed radio systems
operating in the frequency band 3 GHz to 60 GHz**



Reference

REN/TM-04132

Keywords

antenna, DRRS, point-to-point, radio,
transmission, DFRS

ETSI

650 Route des Lucioles
F-06921 Sophia Antipolis Cedex - FRANCE

Tel.: +33 4 92 94 42 00 Fax: +33 4 93 65 47 16

Siret N° 348 623 562 00017 - NAF 742 C
Association à but non lucratif enregistrée à la
Sous-Préfecture de Grasse (06) N° 7803/88

Important notice

Individual copies of the present document can be downloaded from:

<http://www.etsi.org>

The present document may be made available in more than one electronic version or in print. In any case of existing or perceived difference in contents between such versions, the reference version is the Portable Document Format (PDF). In case of dispute, the reference shall be the printing on ETSI printers of the PDF version kept on a specific network drive within ETSI Secretariat.

Users of the present document should be aware that the document may be subject to revision or change of status. Information on the current status of this and other ETSI documents is available at

<http://portal.etsi.org/tb/status/status.asp>

If you find errors in the present document, send your comment to:

editor@etsi.org

Copyright Notification

No part may be reproduced except as authorized by written permission.
The copyright and the foregoing restriction extend to reproduction in all media.

© European Telecommunications Standards Institute 2002.
All rights reserved.

DECT™, PLUGTESTS™ and UMTS™ are Trade Marks of ETSI registered for the benefit of its Members.
TIPHON™ and the TIPHON logo are Trade Marks currently being registered by ETSI for the benefit of its Members.
3GPP™ is a Trade Mark of ETSI registered for the benefit of its Members and of the 3GPP Organizational Partners.

Contents

Intellectual Property Rights	4
Foreword.....	4
Introduction	4
1 Scope	5
2 References	5
3 Definitions, symbols and abbreviations	5
3.1 Definitions	5
3.2 Symbols.....	6
3.3 Abbreviations	6
4 Frequency ranges.....	7
5 Classification of antennas.....	7
6 Electrical characteristics.....	8
6.1 Radiation Pattern Envelope (RPE).....	8
6.2 Cross-Polar Discrimination (XPD).....	29
6.3 Antenna gain	30
7 Conformance tests	30
Annex A (informative): Additional information.....	31
A.1 Mechanical characteristics	31
A.1.1 Environmental characteristics	31
A.1.2 Antenna stability	31
A.2 Antenna input connectors.....	31
A.3 Return loss at the input ports.....	32
A.4 Inter-port isolation.....	32
A.5 Antenna labelling	32
Annex B (informative): Bibliography.....	33
History	34

Intellectual Property Rights

IPRs essential or potentially essential to the present document may have been declared to ETSI. The information pertaining to these essential IPRs, if any, is publicly available for **ETSI members and non-members**, and can be found in ETSI SR 000 314: "*Intellectual Property Rights (IPRs); Essential, or potentially Essential, IPRs notified to ETSI in respect of ETSI standards*", which is available from the ETSI Secretariat. Latest updates are available on the ETSI Web server (<http://webapp.etsi.org/IPR/home.asp>).

Pursuant to the ETSI IPR Policy, no investigation, including IPR searches, has been carried out by ETSI. No guarantee can be given as to the existence of other IPRs not referenced in ETSI SR 000 314 (or the updates on the ETSI Web server) which are, or may be, or may become, essential to the present document.

Foreword

This European Standard (Telecommunications series) has been produced by ETSI Technical Committee Transmission and Multiplexing (TM).

Due to recent increasing interest in this frequency range, the standard has been revised three times, leading to publication of versions 1.2.1, 1.3.1 and 1.4.1.

A short description of the differences in FR5 for these versions is given below:

- V1.2.1: 3 classes (1, 2 and 3), the RPE for class 3 is specified for V polarization only.
- V1.3.1: 4 classes (1, 2, 3 and 4), the RPE for class 3 is the same as 1.2.1 but it is valid for both H and V; class 4 is less stringent than class 3.
- V1.4.1: 3 classes (1, 2 and 3), class 3 give three specifications (3a, 3b and 3c); as class numbers increase, this indicates improved performance.

The RPE for class 3a (equivalent to the class 3 given in versions 1.2.1 and 1.3.1) is now specified for V polarization only.

The RPE for class 3b (the copolar horizontal polarization values are equivalent to the class 4 given in version 1.3.1) is now specified for both polarizations, and the crosspolar values have been improved.

The RPE for class 3c is specified for both polarizations.

National transposition dates	
Date of adoption of this EN:	1 November 2002
Date of latest announcement of this EN (doa):	28 February 2003
Date of latest publication of new National Standard or endorsement of this EN (dop/e):	31 August 2003
Date of withdrawal of any conflicting National Standard (dow):	31 August 2003

Introduction

The purpose of the present document is to define only those antenna parameters necessary to ensure optimum frequency co-ordination between communication services in the frequency range 3 GHz to 60 GHz. Additional parameters appropriate to system implementation may be subject to agreement between the equipment purchaser and supplier. Further guidance is provided in annex A.

1 Scope

The present document addresses the minimum requirements for single main beam, linear polarization, directional antennas to be adopted in conjunction with Point-to-Point (P-P) systems operating in the frequency range 3 GHz to 60 GHz.

Single polarization antennas, dual polarization antennas, dual band/single polarized antennas and dual band/dual polarization antennas are considered.

A regulatory authority may impose tighter requirements than the minimum values given in the present document, in order to maximize the use of the scarce spectrum resources.

2 References

The following documents contain provisions which, through reference in this text, constitute provisions of the present document.

- References are either specific (identified by date of publication and/or edition number or version number) or non-specific.
- For a specific reference, subsequent revisions do not apply.
- For a non-specific reference, the latest version applies.

- [1] WRC-2000: "Final Acts of the World Radiocommunication Conference (WRC-2000)".
- [2] ITU-R Recommendation F.746-6: "Radio-frequency channel arrangements for fixed service systems".
- [3] IEC 60835-2-2 (1994): "Methods of measurement for equipment used in digital microwave transmission systems - Part 2: Measurements on terrestrial radio-relay systems - Section 2: Antenna".
- [4] ETSI EN 301 126-1: "Fixed Radio Systems; Conformance testing; Part 1: Point-to-point equipment - Definitions, general requirements and test procedures".

3 Definitions, symbols and abbreviations

3.1 Definitions

For the purposes of the present document, the following terms and definitions apply:

antenna inter-port isolation: ratio in dB of the power level applied to one port of a multi-port antenna to the power level received in any other port of the same antenna as function of frequency

antennas: part of the transmitting or receiving system that is designed to radiate and/or receive electromagnetic waves

co-polar pattern: diagram representing the radiation pattern of the antenna under test when the reference antenna is similarly polarized, scaled in dBi or dB relative to the measured antenna gain

cross-polar discrimination: difference in dB between the co-polarized main beam gain and the cross-polarized signal measured within a defined region

cross-polar pattern: diagram representing the radiation pattern of the antenna under test when the reference antenna is orthogonally polarized, scaled in dBi or dB relative to the measured antenna gain

frequency band: frequency band of an antenna is the band of frequencies over which the performance characteristics of the antenna are within specified limits

gain: ratio of the radiation intensity, in the main beam axis to the radiation intensity that would be obtained if the power accepted by the antenna was radiated isotropically (value measured in dBi)

half power beamwidth: angle, relative to the main beam axis, between the two directions at which the measured co-polar pattern is 3 dB below the value on the main beam axis

input port(s): Flange(s) or connector(s) through which access to the antenna system is provided. This is shown in the following figure 1 at points D and D'.

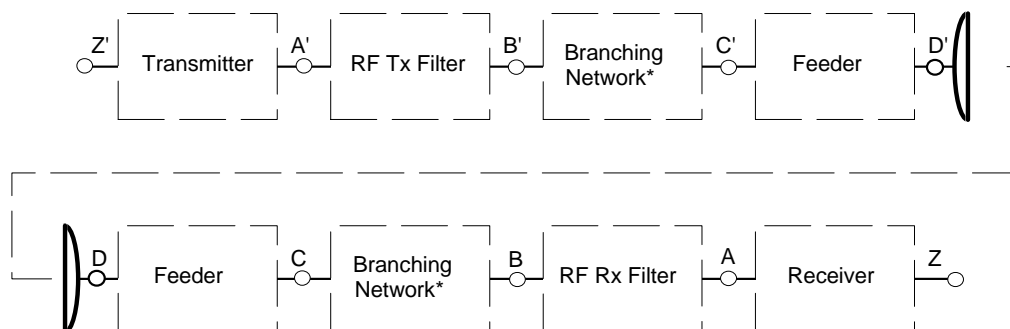

NOTE: The points shown above are reference points only; points B, C and D, B', C' and D' may coincide.

Figure 1: System block diagram

isotropic radiator: hypothetical, lossless antenna having equal radiation intensity in all directions

main beam axis: direction for which the radiation pattern intensity is the maximum

main beam: radiation lobe containing the direction of maximum radiation

radiation pattern envelope: envelope below which the radiation pattern shall fit

radiation pattern: diagram relating power flux density at a constant distance from an antenna to direction relative to the antenna main beam axis

radome: cover of dielectric material, intended for protecting an antenna from the effects of the physical environment

3.2 Symbols

For the purposes of the present document, the following symbols apply:

dB	deciBel
dBi	deciBels relative to an isotropic radiator
GHz	GigaHertz

3.3 Abbreviations

For the purposes of the present document, the following abbreviations apply:

P-P	Point-to-Point
RPE	Radiation Pattern Envelope
VSWR	Voltage Standing Wave Ratio
WRC	World Radiocommunication Conference
XPD	Cross-Polar Discrimination

4 Frequency ranges

The present document applies to sub-bands within 3 GHz to 60 GHz frequency band. Fixed link frequency allocations are in accordance with the WRC-2000 [1] as given in ITU-R Recommendation F.746-6 [2] and other frequency plans.

For the purposes of the present document, the overall frequency range 3 GHz to 60 GHz is divided into six frequency ranges as follows:

Range 1: 3 GHz to 14 GHz;

Range 2: 14 GHz to 20 GHz;

Range 3: 20 GHz to 24 GHz;

Range 4: 24 GHz to 30 GHz;

Range 5: 30 GHz to 47 GHz;

Range 6: 47 GHz to 60 GHz.

5 Classification of antennas

With respect to antenna gain, two gain categories are applicable:

Gain category 1: those antennas which require low gain for co-ordination purposes;

Gain category 2: those antennas which require high gain for co-ordination purposes.

With respect to Radiation Pattern Envelope (RPE), four classes have been identified:

Class 1: Those antennas required for use in networks where there is a low interference potential. Typical examples of a low interference potential might be:

- antennas for use in radio networks where there is a low density deployment, and therefore, a low potential for inter- and intra-system interference, and where high capacity digital radio is proposed;
- antennas for use in radio networks where there is a medium potential for inter- and intra-system interference, and where low capacity digital radio is proposed.

Class 2: Those antennas required for use in networks where there is a high interference potential. Typical examples of a high interference potential might be:

- antennas for use in radio networks where there is a medium potential for inter- and intra-system interference, and where high capacity digital radio is proposed;
- antennas for use in radio networks where there is a high density deployment, and therefore, a high potential for inter- and intra-system interference, and where low capacity digital radio is proposed.

Class 3: Those antennas required for use in networks where there is a very high interference potential. Typical examples of a very high interference potential might be:

- antennas for use in radio networks where there is a high density deployment, and therefore, a high potential for inter- and intra-system interference, and where high capacity digital radio is proposed.

Class 4: Those antennas required for use in networks where there is an extremely high interference potential. Typical examples of an extremely high interference potential might be:

- antennas for use in radio networks where there is a very high density deployment, and therefore, a very high potential for inter- and intra-system interference, and where high capacity digital radio is proposed.

In frequency bands where spectrum congestion is likely to exist, the regulator may insist on the use of higher class antennas.

With respect to cross-Polar Discrimination (XPD), three XPD performance categories have been identified (refer to clause 6.2, table 1):

- XPD category 1: those antennas required to have standard cross-polar discrimination.
- XPD category 2: those antennas required to have high cross-polar discrimination.
- XPD category 3: those antennas required to have high cross-polar discrimination in extended angular region.

6 Electrical characteristics

The antenna manufacturer shall state, for each antenna type, the frequency band of operation and antenna gain at least at the frequency band edges and at mid-band. An antenna which employs a radome shall meet the requirements of the present document with the radome in place.

The antenna system shall radiate a linear (single or dual) polarized wave.

The method of measurement shall be in accordance to IEC 60835-2-2 [3].

6.1 Radiation Pattern Envelope (RPE)

RPE(s) for each class are included, in order to present the maximum flexibility to administrations for optimized co-ordination.

The co-polar and cross-polar radiation pattern measured in the azimuth plane for both polarizations, shall not exceed the RPE(s) defined in the following list:

Range 1:

- Class 1: figure 2a);
- Class 2: figure 2b);
- Class 3: figure 2c);
- Class 4: figure 2d).

Range 2:

- Class 1: figure 3a);
- Class 2: figure 3b);
- Class 3: figure 3c).

Range 3:

- Class 1: figure 4a);
- Class 2: figure 4b);
- Class 3: figure 4c).

Range 4:

- Class 1: figure 5a);
- Class 2: figure 5b).

Range 5:

- Class 1: figure 6a);
- Class 2: figure 6b);
- Class 3a: figure 6c); vertically polarized only
- Class 3b: figure 6d)
- Class 3c: figure 6e)

Range 6:

- Class 1: figure 7a);
- Class 2: figure 7b);
- Class 3: figure 7c), vertically polarized only.

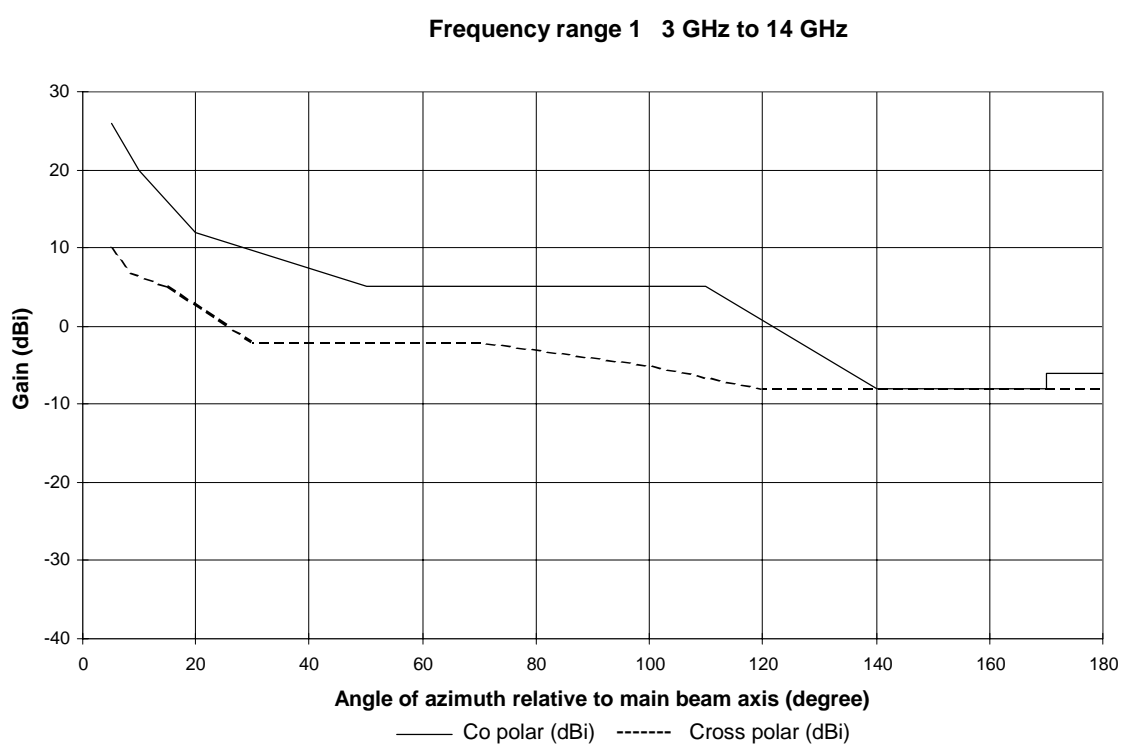

Figure 2a): RPEs for class 1 antennas in the frequency range 1

Frequency range 1 3 GHz to 14 GHz

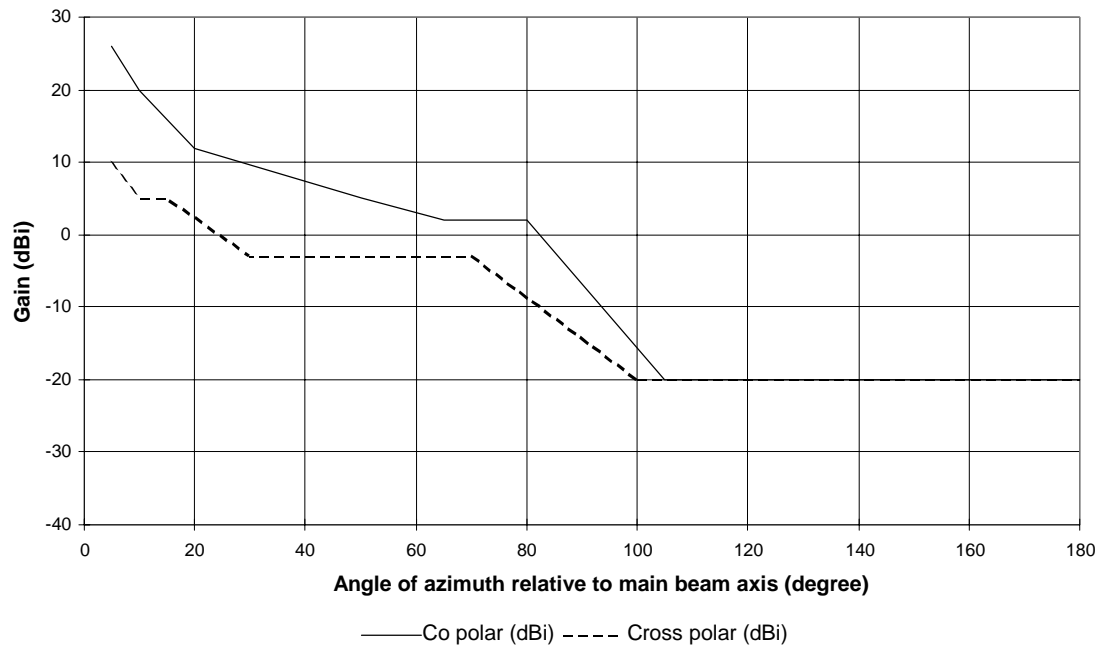
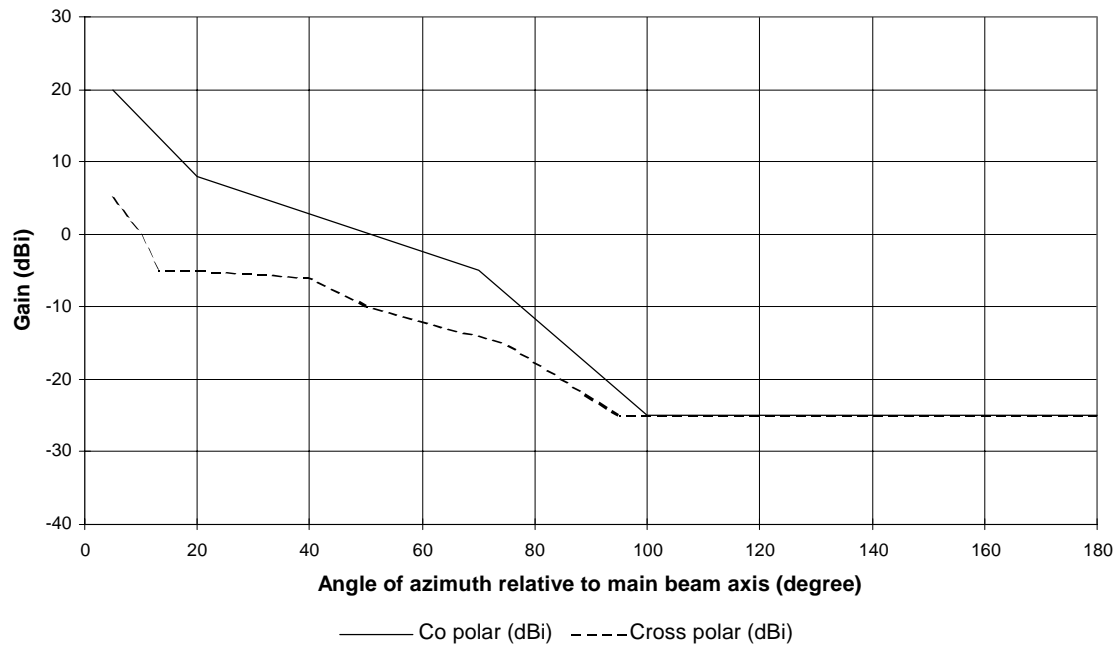

Figure 2b): RPEs for class 2 antennas in the frequency range 1

Frequency range 1 3 GHz to 14 GHz



Angle (degrees)	Co-polar (dBi)	Angle (degrees)	Cross-polar (dBi)
5	20	5	5
20	8	10	0
70	-5	13	-5
100	-25	20	-5
180	-25	40	-6
		50	-10
		75	-15
		95	-25
		180	-25

Figure 2c): RPEs for class 3 antennas in the frequency range 1

Frequency range 1 3 GHz to 14 GHz

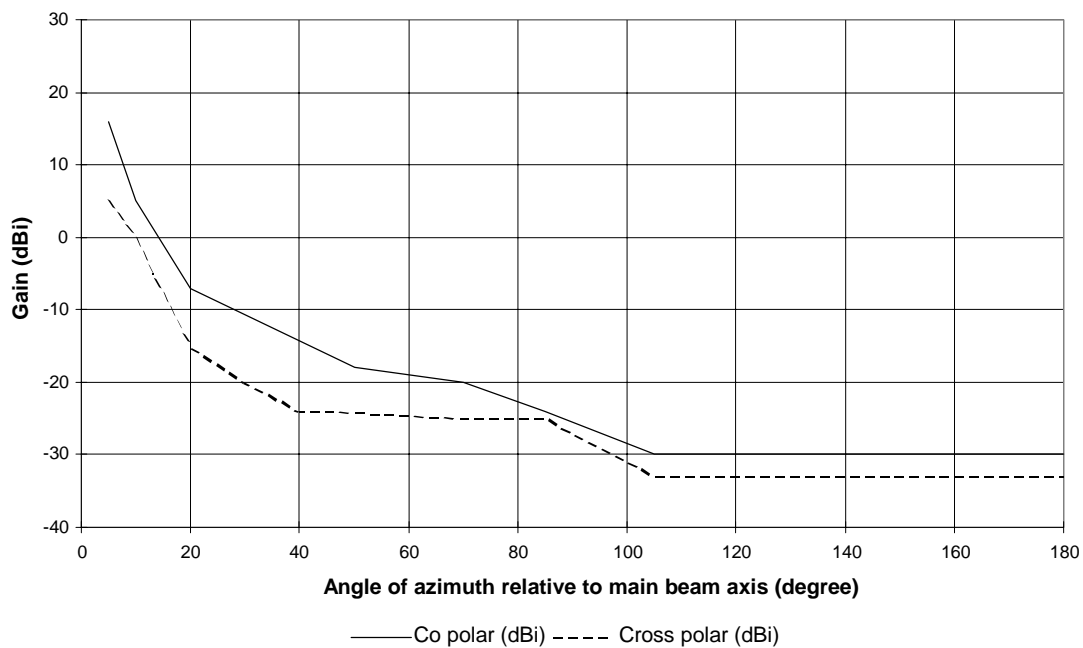

Figure 2d): RPEs for class 4 antennas in the frequency range 1

Frequency range 2 14 GHz to 20 GHz

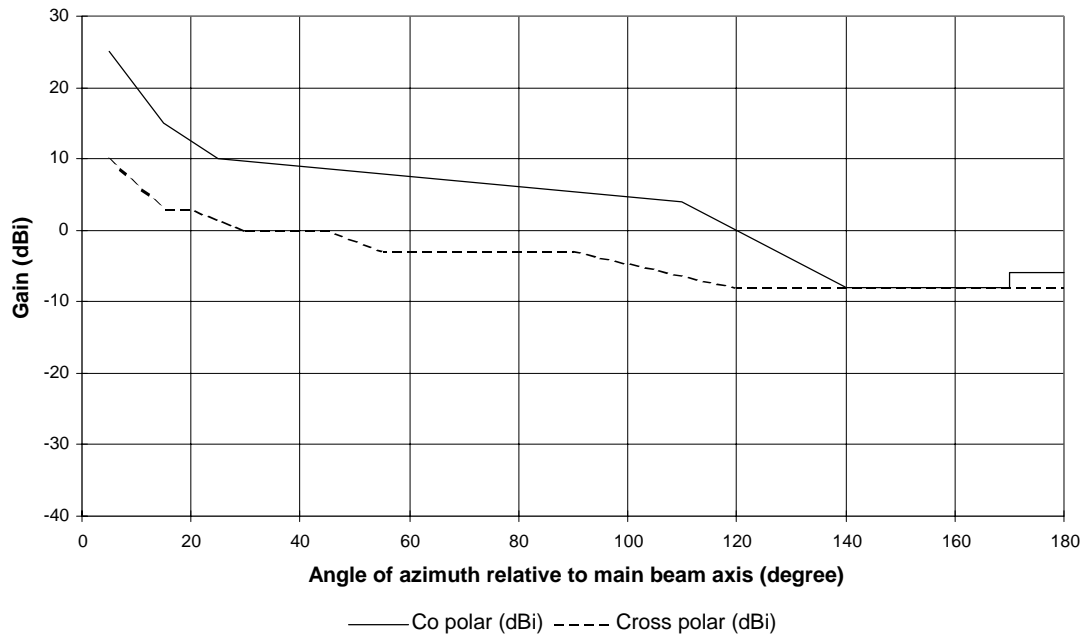
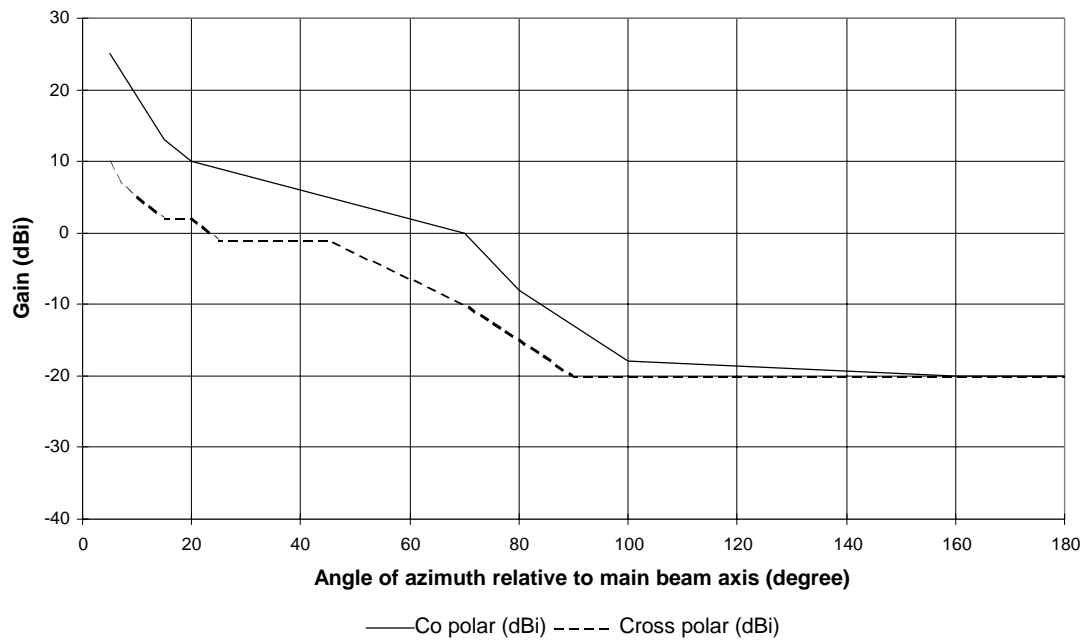

Figure 3a): RPEs for class 1 antennas in the frequency range 2

Frequency range 2 14 GHz to 20 GHz



Angle (degrees)	Co-polar (dBi)	Angle (degrees)	Cross-polar (dBi)
5	25	5	10
15	13	7	7
20	10	15	2
70	0	20	2
80	-8	25	-1
100	-18	45	-1
160	-20	70	-10
180	-20	90	-20
		180	-20

Figure 3b): RPEs for class 2 antennas in the frequency range 2

Frequency range 2 14 GHz to 20 GHz

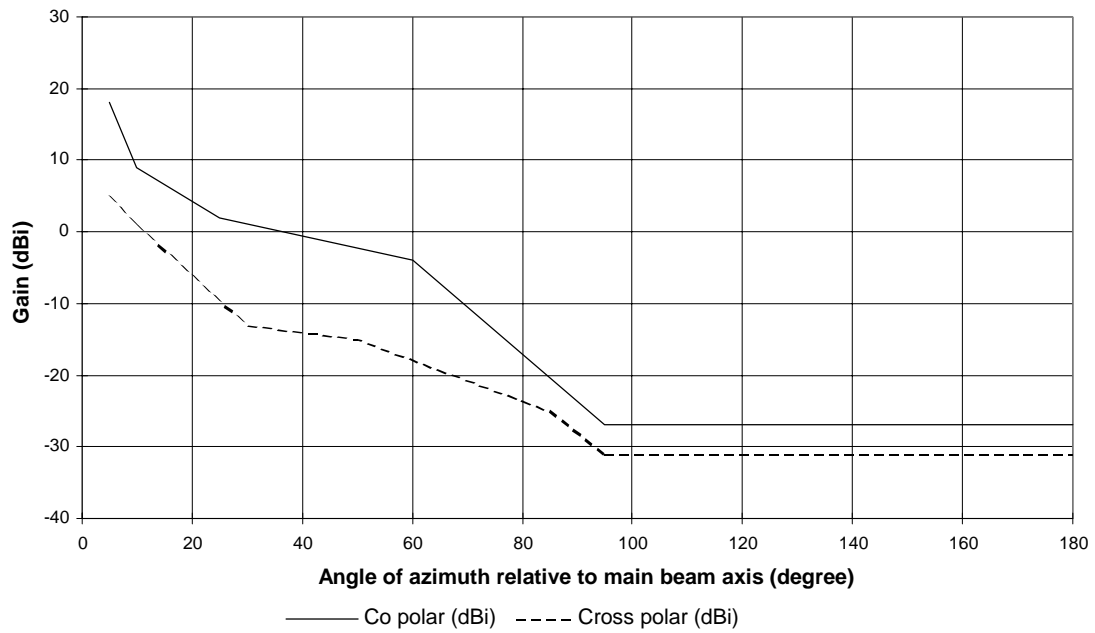

Angle (degrees)	Co-polar (dBi)	Angle (degrees)	Cross-polar (dBi)
5	18	5	5
10	9	10	1
25	2	30	-13
60	-4	50	-15
95	-27	85	-25
180	-27	95	-31
		180	-31

Figure 3c): RPEs for class 3 antennas in frequency range 2

Frequency range 3 20 GHz to 24 GHz

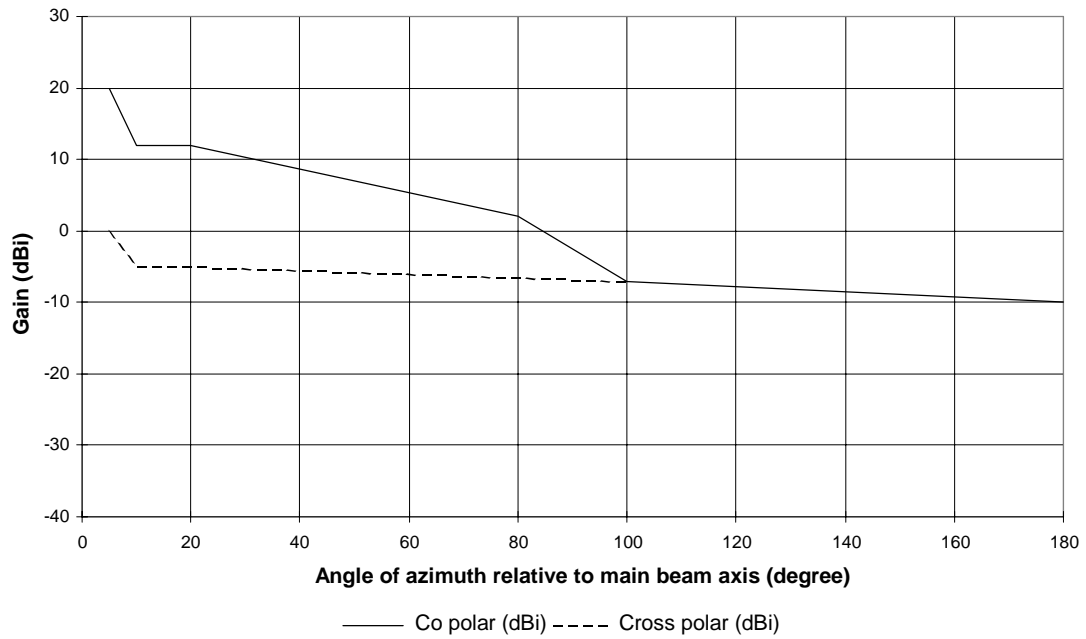

Angle (degrees)	Co-polar (dBi)	Angle (degrees)	Cross-polar (dBi)
5	20	5	0
10	12	10	-5
20	12	20	-5
80	2	100	-7
100	-7	180	-10
180	-10		

Figure 4a): RPEs for antennas class 1 in the frequency range 3

Frequency range 3 20 GHz to 24 GHz

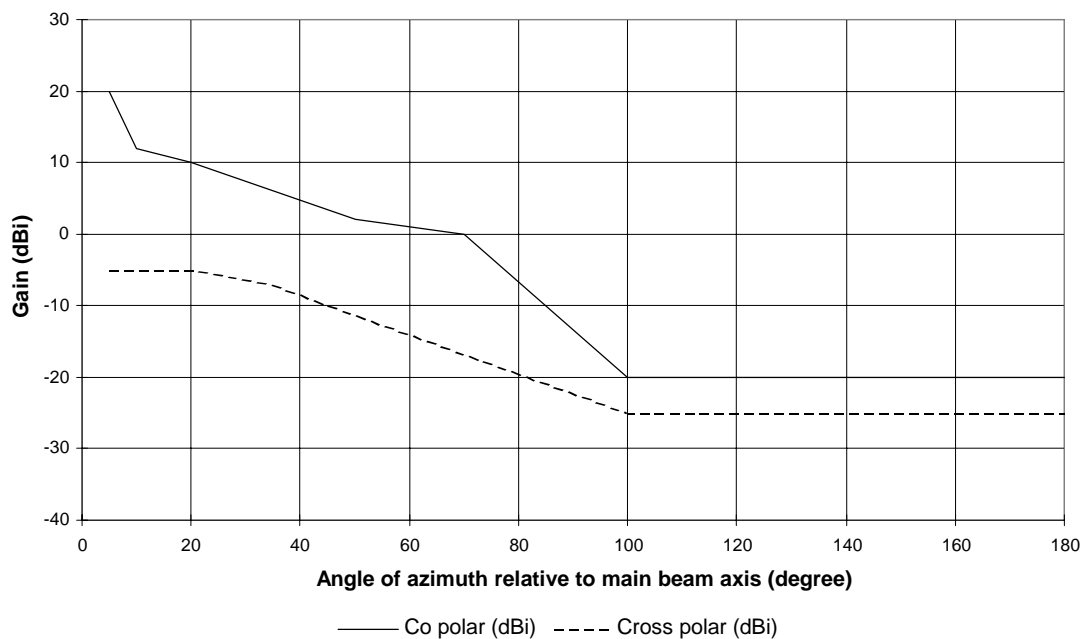
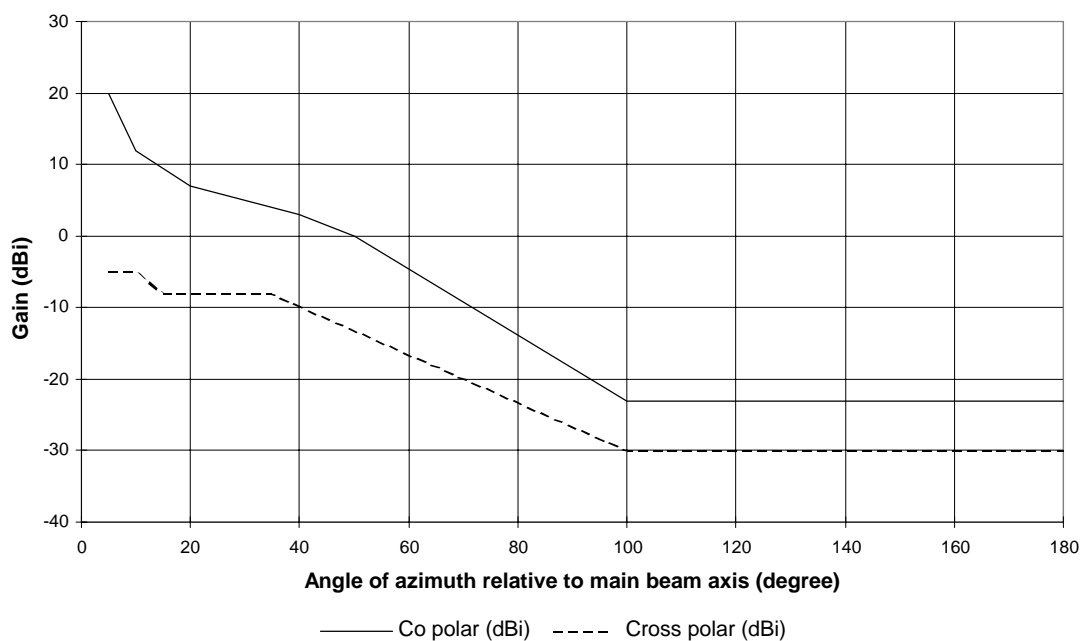

Figure 4b): RPEs for class 2 antennas in the frequency range 3

Frequency range 3 20 GHz to 24 GHz



Angle (degrees)	Co-polar (dBi)	Angle (degrees)	Cross-polar (dBi)
5	20	5	-5
10	12	10	-5
20	7	15	-8
40	3	35	-8
50	0	100	-30
100	-23	180	-30
180	-23		

Figure 4c): RPEs for class 3 antennas in the frequency range 3

Frequency range 4 24 GHz to 30 GHz

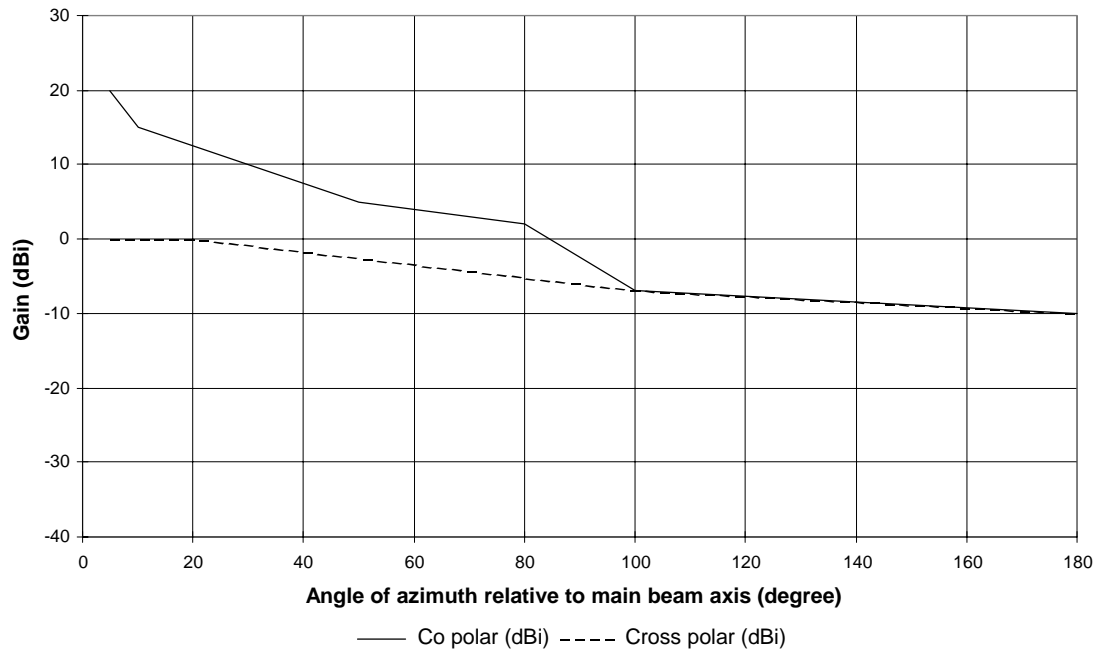

Angle (degrees)	Co-polar (dBi)	Angle (degrees)	Cross-polar (dBi)
5	20	5	0
10	15	20	0
50	5	100	-7
80	2	180	-10
100	-7		
180	-10		

Figure 5a): RPEs for class 1 antennas in the frequency range 4

Frequency range 4 24 GHz to 30 GHz

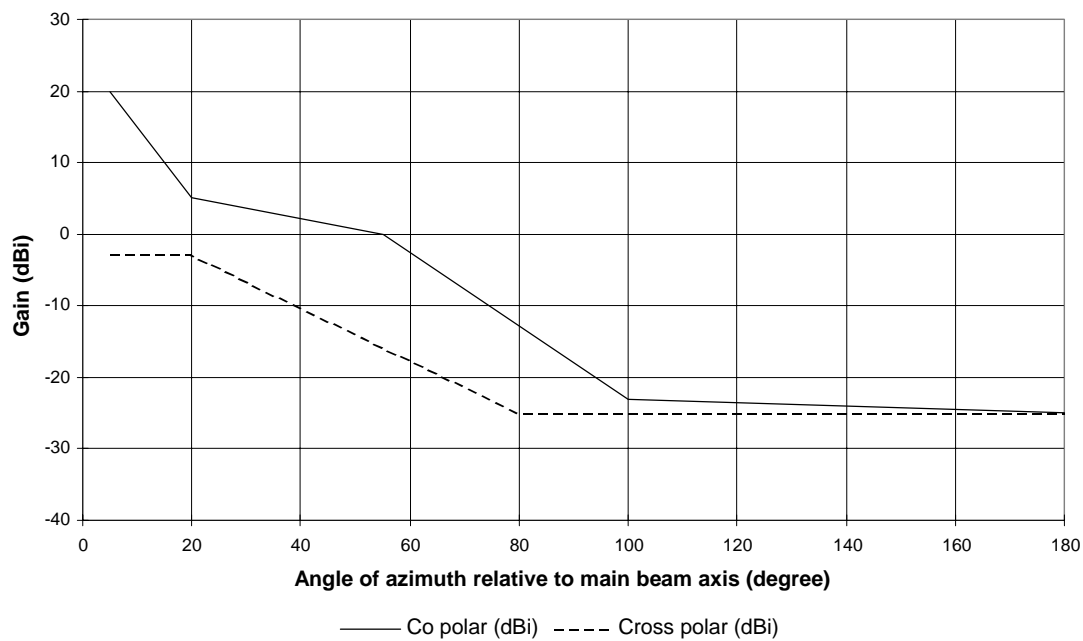

Angle (degrees)	Co-polar (dBi)	Angle (degrees)	Cross-polar (dBi)
5	20	5	-3
20	5	20	-3
55	0	80	-25
100	-23	180	-25
180	-25		

Figure 5b): RPEs for class 2 antennas in the frequency range 4

Frequency range 5 30 GHz to 47 GHz

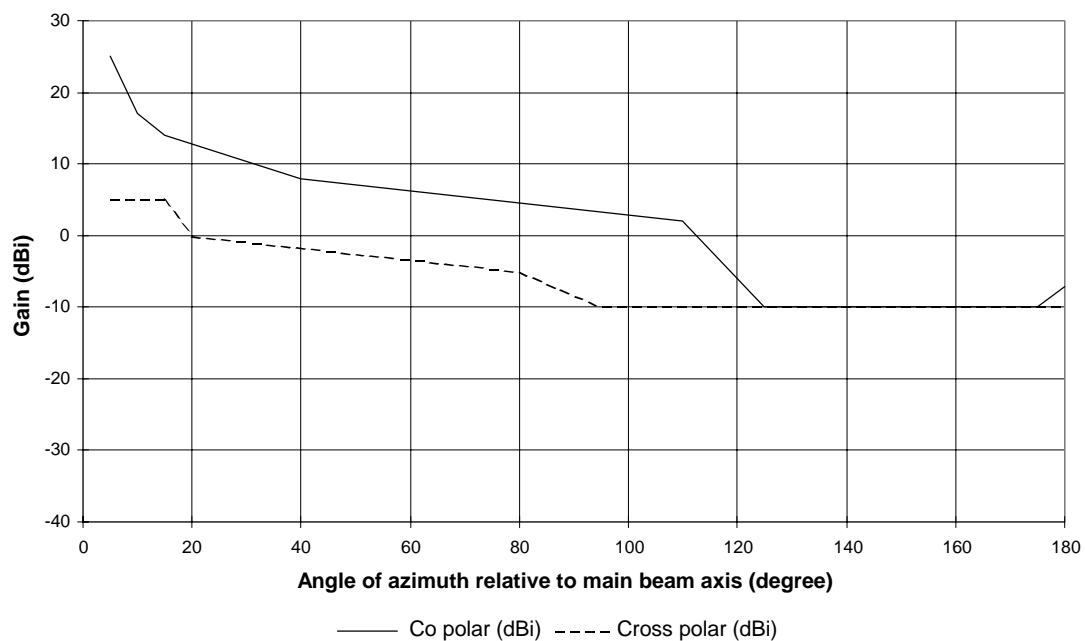

Angle (degrees)	Co-polar (dBi)	Angle (degrees)	Cross-polar (dBi)
5	25	5	5
10	17	15	5
15	14	20	0
40	8	80	-5
110	2	95	-10
125	-10	180	-10
175	-10		
180	-7		

Figure 6a): RPEs for class 1 antennas in the frequency range 5

Frequency range 5 30 GHz to 47 GHz

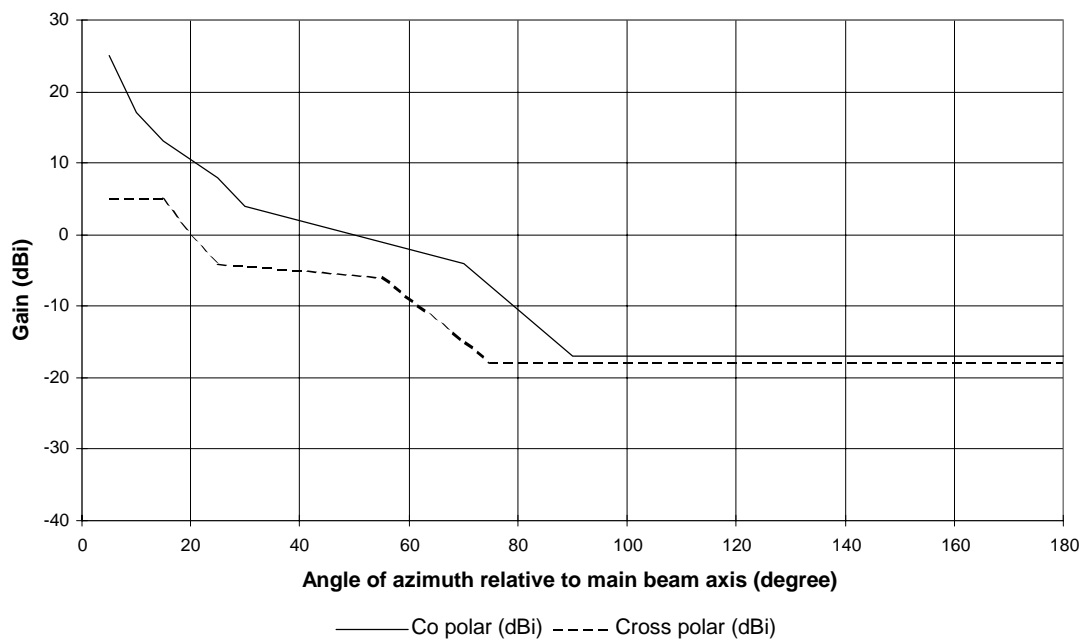
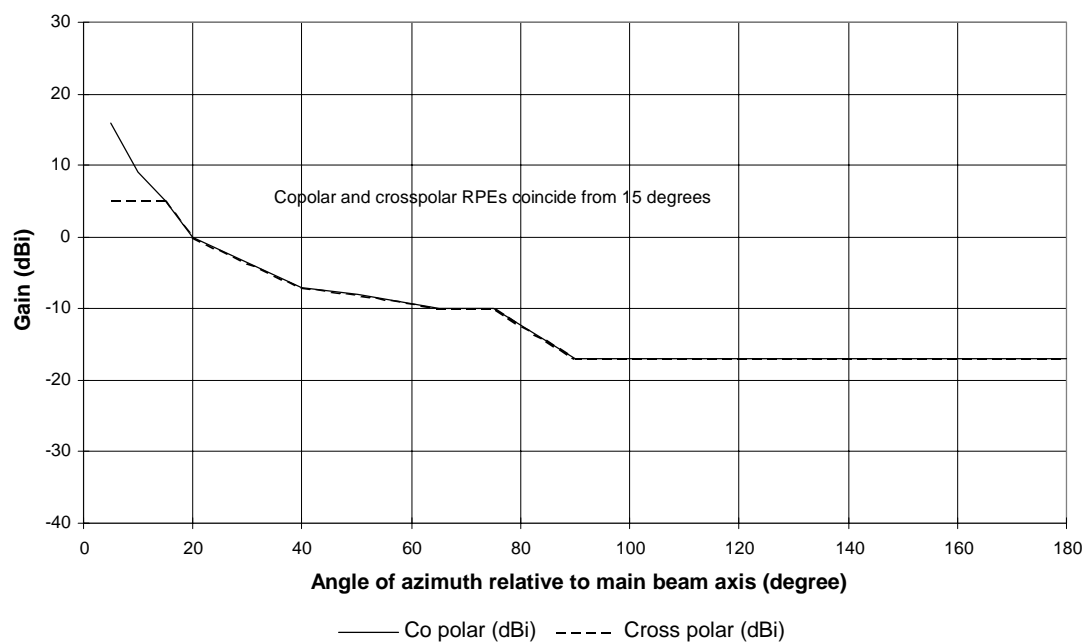

Figure 6b): RPEs for class 2 antennas in the frequency range 5

Frequency range 5 30 GHz to 47 GHz



Angle (degrees)	Co-polar (dBi)	Angle (degrees)	Cross-polar (dBi)
5	16	5	5
10	9	15	5
15	5	20	0
20	0	40	-7
40	-7	50	-8
50	-8	65	-10
65	-10	75	-10
75	-10	90	-17
90	-17	180	-17
180	-17		

Figure 6c): RPEs for class 3a antennas in the frequency range 5, vertically polarized only

Frequency range 5 30 GHz to 47 GHz

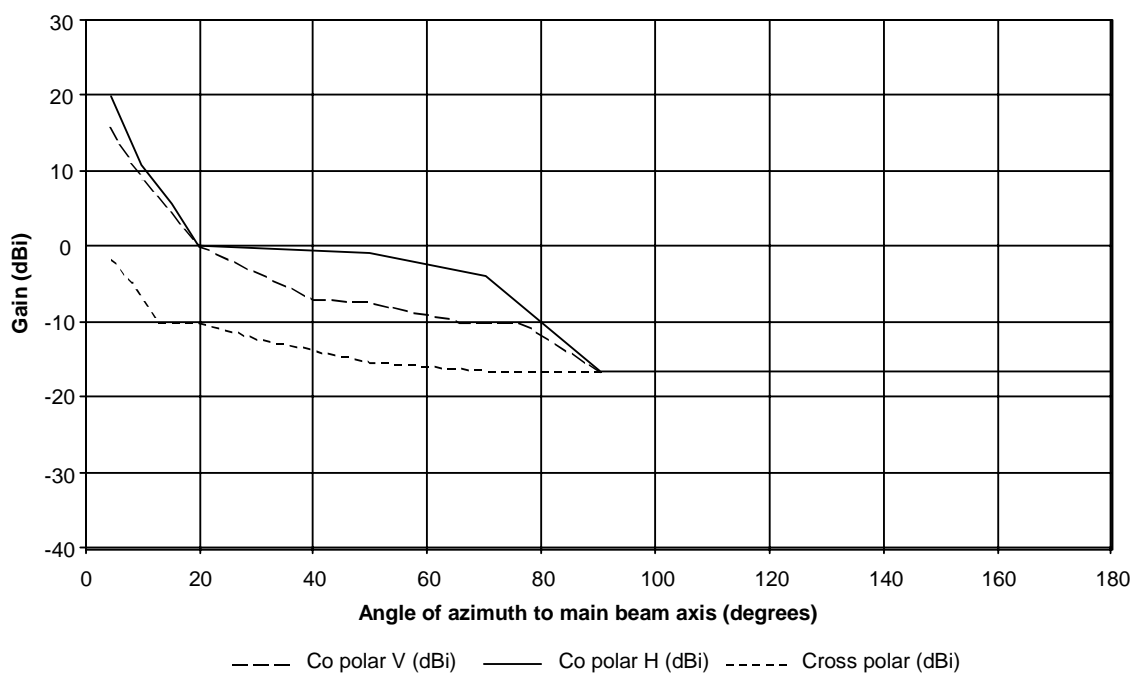

Angle (degrees)	Co-polar H (dBi)	Angle (degrees)	Co-polar V (dBi)	Angle (degrees)	Cross-polar (dBi)
5	20	5	16	5	-2
10	11	10	9	8	-5
15	6	15	5	12	-10
20	0	20	0	20	-10
50	-1	40	-7	30	-12
70	-4	50	-8	50	-15
90	-17	65	-10	70	-17
180	-17	75	-10	180	-17
		90	-17		
		180	-17		

Figure 6d): RPEs for class 3b antennas in the frequency range 5

Frequency range 5 30 GHz to 47 GHz

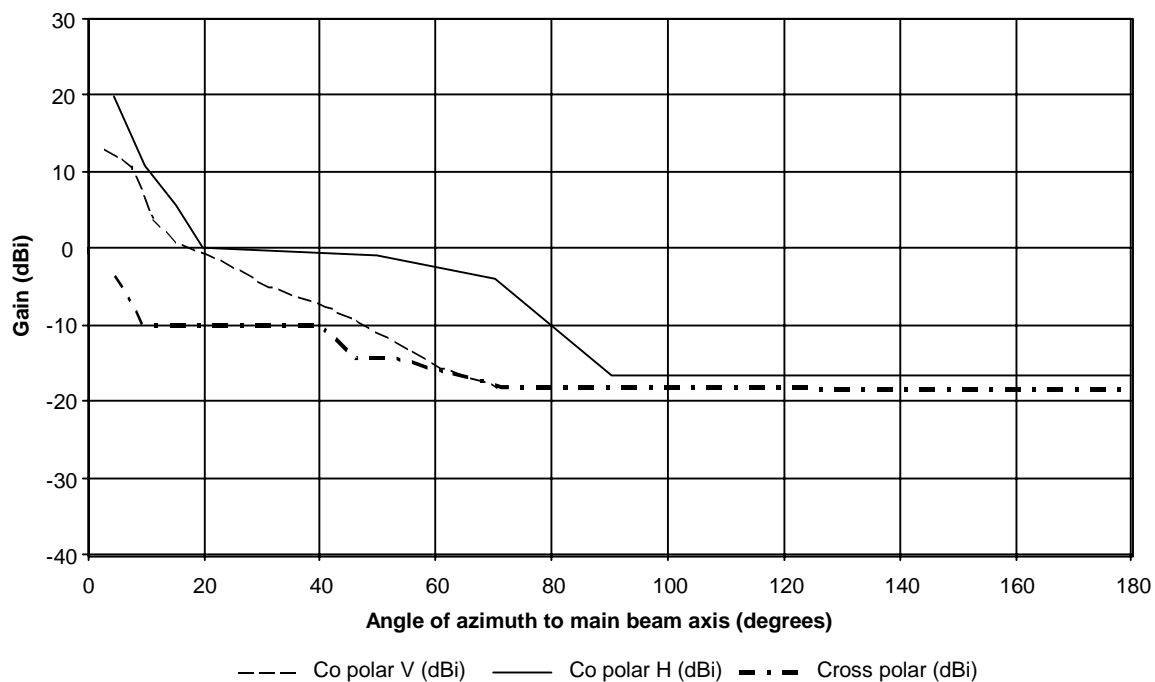

Angle (degrees)	Co-polar H (dBi)	Angle (degrees)	Co-polar V (dBi)	Angle (degrees)	Cross-polar (dBi)
5	20	5	12	5	-4
10	11	9	9	9	-8
15	6	10	6	10	-10
20	0	15	2	15	-10
50	-1	20	0	20	-10
70	-4	30	-4	30	-10
90	-17	40	-7	40	-10
180	-17	45	-9	45	-13
		60	-14	55	-13
		70	-18	70	-18
		180	-18	180	-18

Figure 6e): RPEs for class 3c antennas in the frequency range 5

Frequency range 6 47 GHz to 60 GHz

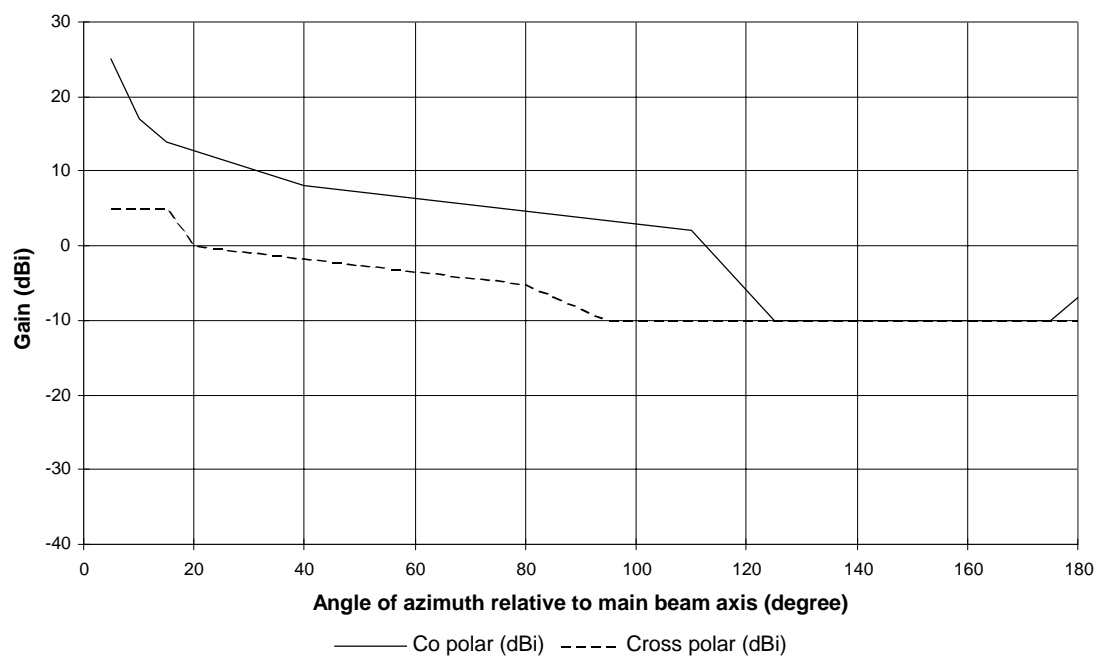

Angle (degrees)	Co-polar (dBi)	Angle (degrees)	Cross-polar (dBi)
5	25	5	5
10	17	15	5
15	14	20	0
40	8	80	-5
110	2	95	-10
125	-10	180	-10
175	-10		
180	-7		

Figure 7a): RPEs for class 1 antennas in the frequency range 6

Frequency range 6 47 GHz to 60 GHz

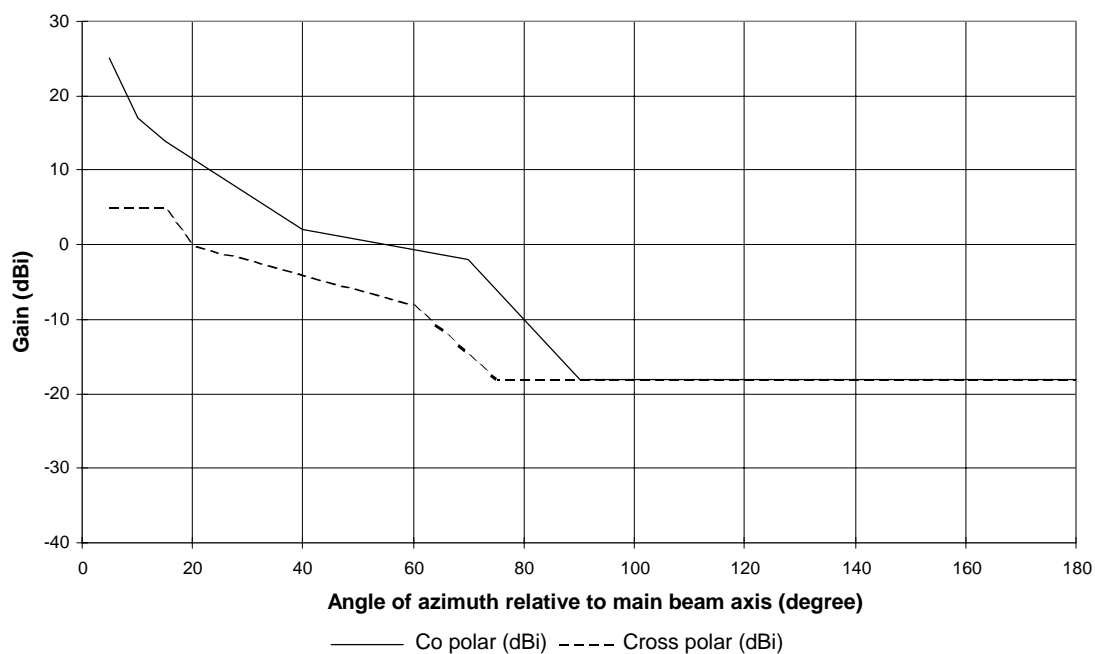

Angle (degrees)	Co-polar (dBi)	Angle (degrees)	Cross-polar (dBi)
5	25	5	5
10	17	15	5
15	14	20	0
40	2	60	-8
70	-2	75	-18
90	-18	180	-18
180	-18		

Figure 7b): RPEs for class 2 antennas in the frequency range 6

Frequency range 6 47 GHz to 60 GHz

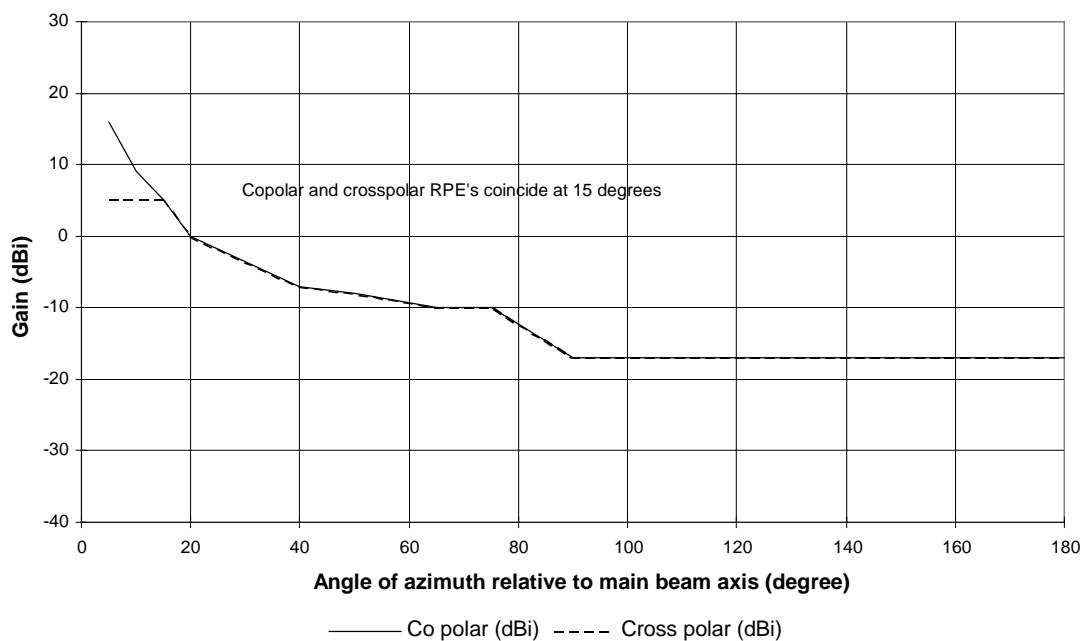

Angle (degrees)	Co-polar (dBi)	Angle (degrees)	Cross-polar (dBi)
5	16	5	5
10	9	15	5
15	5	20	0
20	0	40	-7
40	-7	50	-8
50	-8	65	-10
65	-10	75	-10
75	-10	90	-17
90	-17	180	-17
180	-17		

Figure 7c): RPEs for class 3 antennas in the frequency range 6, vertically polarized only

6.2 Cross-Polar Discrimination (XPD)

The XPDs corresponding to the RPEs referenced in clause 6.1 shall be equal to or higher than those values defined in table 1.

In figures 8 and 9, masks are given for XPD measurements around the main beam axis.

Table 1: XPD values corresponding to RPE values in clause 6.1

Frequency ranges	Standard XPD (dB) (note 1)	High XPD (dB)	
		Category 2 (referred to figure 8)	Category 3 (referred to figure 9)
Range 1	27	35	35
Range 2	27	34	40 (note 2)
Range 3	27	34	34
Range 4	27	34	34
Range 5	27	30	30
Range 6	27	n.a.	n.a.

NOTE 1: With respect to the azimuthal cut within the 1 dB co-polarized main beam axis.
NOTE 2: Referred to region A in figure 9.

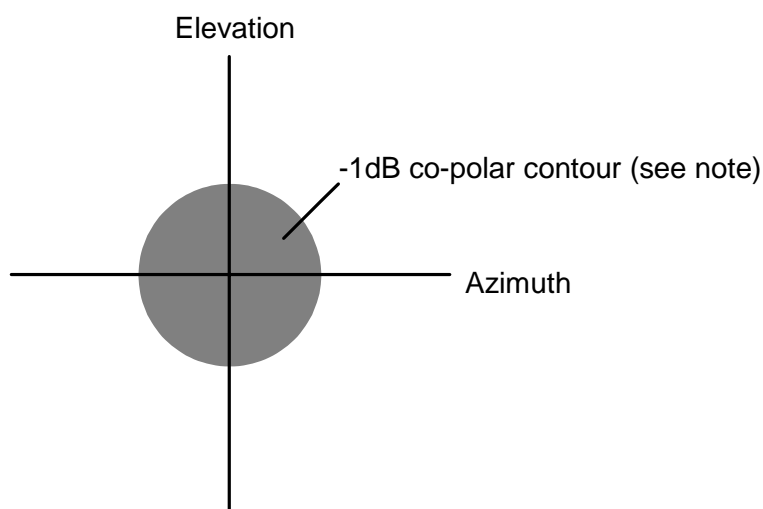

NOTE: For the dual band antennas -1 dB contour for highest frequency band shall be used.

Figure 8: Mask for XPD measurements around the main beam axis

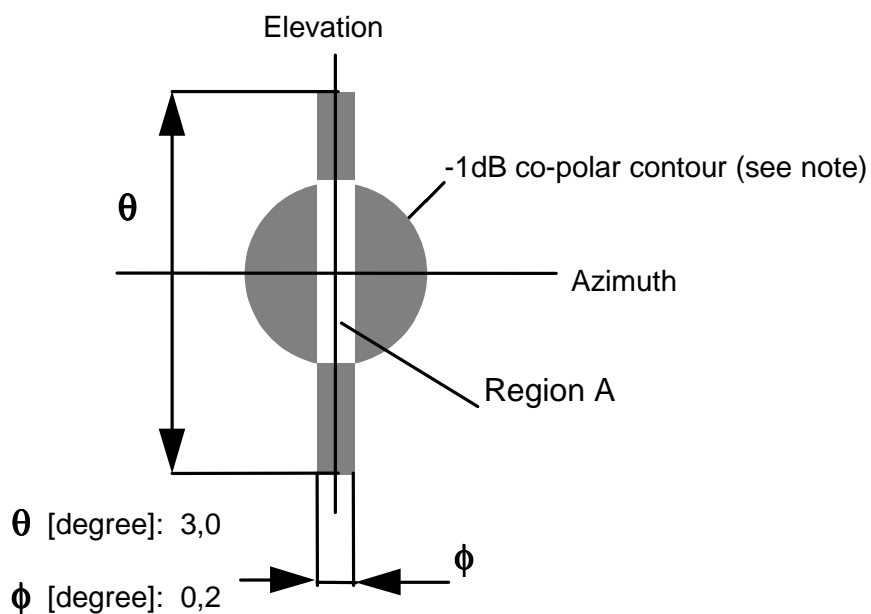

NOTE: For the dual band antennas -1 dB contour for highest frequency band shall be used.

Figure 9: Mask for XPD measurements around the main beam axis

6.3 Antenna gain

The gain of the antenna shall be expressed relative to an isotropic radiator (dBi). Antenna gain shall exceed the minimum value throughout its operational frequency range. There are two categories of minimum antenna gain covered by the present document as follows:

- Gain Category 1: 28 dBi;
- Gain Category 2: 32 dBi.

Regulators will specify one gain category which is to be used for each co-ordination task.

7 Conformance tests

For antenna parameters, EN 301 126-1 [4] shall apply.

Annex A (informative): Additional information

A.1 Mechanical characteristics

A.1.1 Environmental characteristics

The antennas should be designed to operate within a temperature range of -45°C to $+45^{\circ}\text{C}$ with a relative humidity up to 100 % with salt mist, industrial atmosphere, UV-radiation etc.

The temperature range could be divided in two parts where at least one of the following ranges should be covered:

- 1) -33°C to $+40^{\circ}\text{C}$;
- 2) -45°C to $+45^{\circ}\text{C}$.

The antennas should be designed to meet wind survival ratings specified in table A.1.

Table A.1

Antenna type	Wind velocity m/s (km/h)	Ice load (density 7 kN/m ³)
Normal duty	55 (200)	25 mm radial ice
Heavy duty	70 (252)	25 mm radial ice

A.1.2 Antenna stability

The antenna equipment should be stable under the most severe operational conditions at the site of intended application.

For installation on trellis or towers, the deviation of the antenna main beam axis should not be more than 0,3 times the -3 dB beam width under the conditions specified in table A.2.

Table A.2

Antenna type	Wind velocity m/s (km/h)	Ice load (density 7 kN/m ³)
Normal duty	30 (110)	25 mm radial ice
Heavy duty	45 (164)	25 mm radial ice

A.2 Antenna input connectors

When flanges are provided at the input port of the antenna they should be in accordance with IEC 60154.

For antennas which are integrated to the radio equipment proprietary connection designs may be utilized.

For antennas using coaxial input ports the connectors should conform to IEC 60169.

Other interconnection design should be agreed between the equipment supplier and purchaser in line with the overall system design requirements.

A.3 Return loss at the input ports

The minimum return loss should be agreed between the equipment supplier and purchaser in line with the overall system design requirements.

For guidance, antennas with a Voltage Standing Wave Ratio (VSWR) in a range of 1,06 to 1,2 are typical.

A.4 Inter-port isolation

The isolation between the input ports of a dual polarized antenna should be agreed between the equipment supplier and purchaser in line with the overall system design requirements.

For guidance the isolation between ports may be between 35 dB to 50 dB.

A.5 Antenna labelling

It is recommended that the antennas should be clearly identified with a weather-proof and permanent label showing the manufacturers name, antenna type, serial number and type approval reference number which identifies the country of origin.

Annex B (informative): Bibliography

IEC 60050-712: "International Electrotechnical Vocabulary - Chapter 712: Antennas".

IEEE Standard 145: "Definitions, antennas".

DIN 45.030-1: "Definitions, antennas".

DIN 45.030-2: "Concepts, antennas".

ITU-R Recommendation F.699-3: "Reference radiation patterns for line-of-sight radio-relay system antennas for use in coordination studies and interference assessment in the frequency range from 1 to about 40 GHz".

CCIR Report 614-3 (1990): "Reference radiation patterns etc.".

ANSI/IEEE Standard 149: "Antenna measurements".

IEC 60154-1: "Flanges for waveguides. Part 1: General requirements".

IEC 60154-2: "Flanges for waveguides. Part 2: Relevant specifications for flanges for ordinary rectangular waveguides".

IEC 60169-1 and applicable sub-parts: "Radio-frequency connectors. Part 1: General requirements and measuring methods".

ANSI/EIA-195-C (1985): "Terrestrial microwave relay antennas".

MIL-G-24.211: "Gaskets for waveguide flanges".

History

Document history		
Edition 1	June 1999	Publication as ETS 300 833
V1.2.1	August 2000	Publication
V1.3.1	August 2001	Publication
V1.4.1	July 2002	One-step Approval Procedure OAP 20021101: 2002-07-03 to 2002-11-01
V1.4.1	November 2002	Publication